

2006 EDITION

# RESTRAINED JOINTS

FOR DUCTILE IRON PIPELINES



FOR WATER & WASTEWATER, FIRE PROTECTION

**MORE  
THAN  
JUST  
PIPE.**

**U.S.  
PIPE**

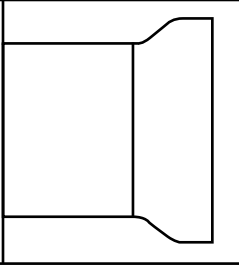

# RESTRAINED JOINTS



2006 EDITION

P 2

## Table of Contents

Use and Application	3
Thrust Forces	4
Changes of Diameter (also Dead Ends and Valves)	6
Methods of Thrust Resistance	6
Thrust Block Limitations	7
Restrained Joint Piping	8
Combining Thrust Blocks and Restrained Joints	9
Design Parameters	10
Thrust Restraint Calculation Assistance	12
Restrained Joint Pipe and Fittings	13
TR FLEX® Pipe and Fittings	15
Field Cuts – TR FLEX GRIPPER® Ring	17
TR FLEX® Pipe and Fittings	19
Specifications for TR FLEX® Pipe and Fittings	21
FIELD LOK 350® Gaskets	23
FIELD LOK 350® Gaskets – Pipe Diameters and Circumference for Joints	24
FIELD LOK 350® Gaskets	25
MJ FIELD LOK® Gasket	26
MJ FIELD LOK® Gasket Product Overview	27
MJ FIELD LOK® Application Notes	28
MJ FIELD LOK® Gasket Performance and Dimensions	29
Warnings and Limitations – Restrained Joints	30
Notes Regarding the Use of Restrained Joint Pipe	32
Products for Water, Waste Water and Fire Protection	33

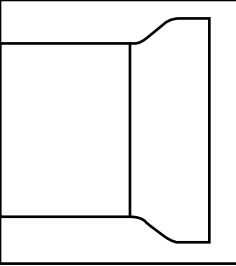

# RESTRAINED JOINTS



2006 EDITION

P 3

## Use and Application

In a straight section of a Ductile Iron pipeline, the hydrostatic forces are balanced. Wherever the pipeline changes direction or diameter, such as at a bend, tee or a reducer, the hydrostatic forces create an unbalanced thrust force in the line. This unbalanced thrust force can cause the line to move or its joints to separate unless the thrust force is counterbalanced. Unbalanced thrust forces are commonly counterbalanced with thrust blocks, restrained pipe joints, or a combination of the two.

Conventional Ductile Iron pipe joints are push-on type joints or bolted mechanical joints, neither of which is restrained. These joints do not offer any significant resistance to joint separation.

U.S. Pipe has developed restrained joint products for Ductile Iron pipelines. These include:

- TR FLEX® Pipe and Fittings, a restrained push-on joint
- FIELD LOK 350® Gaskets, which are used to restrain push-on TYTON JOINT® Pipe and Fittings
- MJ FIELD LOK® Gaskets which are used to restrain mechanical joint pipe and fittings

Tips and suggestions for pipeline design and installation are found throughout the brochure. These tips and suggestions are based on extensive field experience with U.S. Pipe's products and may not be applicable to other manufacturers' products.

The thrust restraint concepts presented here are based on the design method developed by the Ductile Iron Pipe Research Association (DIPRA). Copies of the DIPRA brochure, Thrust Restraint Design for Ductile Iron Pipe, are available from DIPRA\* or from U.S. Pipe representatives.

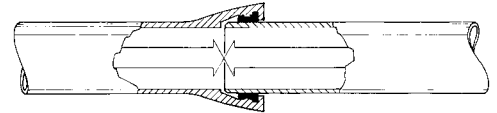

**Figure 1:** *Balanced Hydrostatic Forces Within a Long Straight Pipeline*

\*Ductile Iron Pipe Research Association, 245 Riverchase Parkway East, Suite 0 Birmingham, Alabama 35244, Phone (205) 402-8700, Fax (205) 402-8730-

TR FLEX®, FIELD LOK 350®, MJ FIELD LOK®, and TYTON JOINT® are Registered Trademarks of U.S. Pipe and Foundry Company.

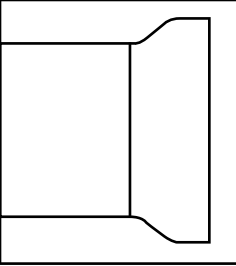

# RESTRAINED JOINTS



2006 EDITION

P 4

## Thrust Forces

The axial hydrostatic force (F) of any pipeline is equal to the product of the internal pressure of the line (P) and the cross-sectional area of the line (A).

$$F = PA$$

### Changes of Direction

At any change of direction of a line, the axial force upstream of the change of direction will not be in line with the downstream force, and an unbalanced lateral thrust force will be generated. The larger the change of direction, the larger will be the unbalanced lateral force. Significant changes of direction are generally encountered at bends, tees, or wyes.

### Thrust at a Bend

At a bend, the magnitude of the lateral thrust force is a function of the angle  $\Theta$  of the bend:

$$T = 2PA \sin(\Theta/2)$$

### Thrust at a Tee or Wye

At a tee or wye, an unbalanced thrust force is generated equal to the hydrostatic force of the branch, where (Ab) is the area of the branch:

$$T = PA_b$$

The axial hydrostatic forces of the run are balanced.

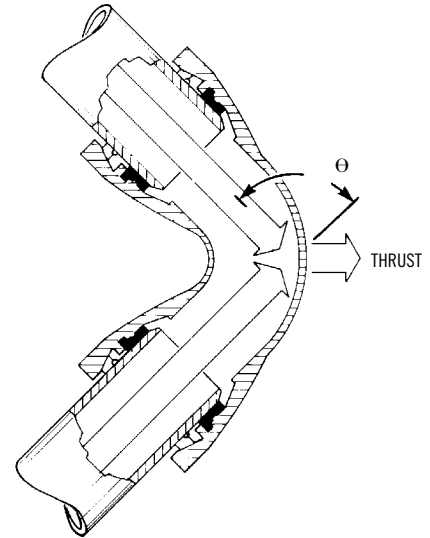

Figure 2: Thrust Force Generated at a Bend

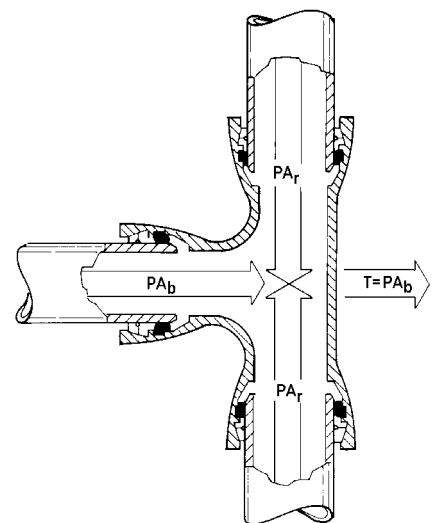

Figure 3: Thrust Force Generated at a Tee

## Changes of Diameter (Also Dead Ends and Valves)

### Thrust at a Reducer

At a change of diameter in a line, such as at reducer, the axial hydrostatic force in the larger diameter will be greater than the axial force in the smaller diameter. An unbalanced axial thrust force equal to the difference in the two hydrostatic forces will be generated. The greater the change in diameter, the greater will be the unbalanced axial thrust force. The magnitude of the thrust force is,

$$T = P(A_L - A_S)$$

where  $(A_L)$  and  $(A_S)$  are the cross sectional areas of the larger and smaller diameter sections, respectively.

### Thrust at a Dead End or Valve

At a dead end or closed valve in a line an unbalanced axial thrust force equal to the axial hydrostatic force is generated.

$$T = PA$$

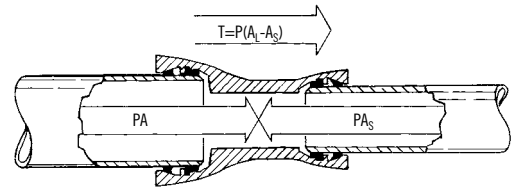

Figure 4: Thrust Force Generated at a Reducer

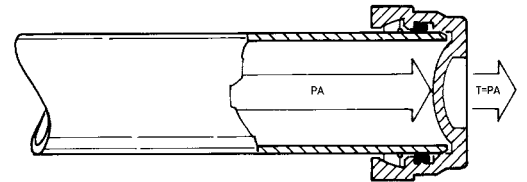
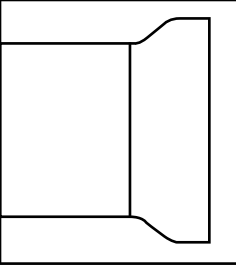

Figure 5: Thrust Force Generated at a Dead End



# RESTRAINED JOINTS



2006 EDITION

P 6

## Methods of Thrust Resistance

Where there are only gradual changes of direction in the line, the lateral thrust forces are normally counterbalanced by the friction between the pipe and the soil along the length of piping, and joint restraint is not required.

However, when higher pressures, poor soil conditions or significant changes of direction or diameter are encountered, the thrust forces may be too great to be resisted by the soil surrounding an unrestrained joint. In such cases, restraining the joints adjacent to the unbalanced thrust force or using a thrust block can provide additional thrust resistance. It is important to understand that in these situations, the thrust forces are actually being resisted by friction between the pipe and the soil.

### Thrust Blocks

Concrete thrust blocks are commonly used to resist unbalanced thrust forces. A thrust block may be constructed between the fitting and the undisturbed side or bottom of the trench. The base of the thrust block is designed to support the anticipated thrust loads by providing a bearing area through which the thrust forces can be transferred to the soil without exceeding the bearing capacity of the soil.

**NOTE:** *If all the joints of the pipeline are restrained and fully extended, the piping system can carry the thrust loads without need of soil resistance. Totally restrained pipelines can be used above ground, underwater, or in swampy areas to provide thrust restraint and simplify installation where there is little or no soil support.*

## Thrust Block Limitations

Several conditions limit the practicality of thrust blocks.

### Soil Limitation

The effectiveness of a thrust block depends on the type of surrounding soil. The poorer the bearing capacity of the soil, the larger the thrust block must be to provide an adequate bearing area. Cost considerations may prohibit the use of large thrust blocks. In some cases, such as in swamp lands or marshes, the bearing capacity of the soil may be such that thrust blocks may not be feasible.

### Space Limitations

In confined areas, such as excavations under city streets, there may not be adequate space to install a thrust block large enough to resist the anticipated thrust forces.

### Future Excavations

The possibility of future excavations can restrict the usefulness of thrust blocks. Excavations that remove the soil support from thrust blocks of an operating pipeline can result in joint separation and line failure.

When determining the thrust restraint requirement during a project design phase, consideration should be given to the impact of future growth and/or facility expansion on the area immediately adjacent to the pipeline and potential thrust block locations. Should future utilities be installed within the pipeline right of way, the installation effort may compromise the soil behind the thrust block allowing the thrust block to move and resulting in a pipe joint separation. Such a situation is very common on industrial plant sites and college and business office campuses where facility expansion and upgrades are constantly being implemented. If there is a possibility of pipe having to be supported by a thrust block or soil supporting the pipeline, consideration must be given to use of restrained joints to fulfill the pipeline thrust restraint requirements.

### Where Open Trenches are Not Allowed

Installation and design conditions must be taken into account when designing thrust restraint. Building large thrust blocks may involve constructing forms and pouring several tons of concrete. The concrete must be at least partially cured before the trench can be closed. If safety requirements dictate that the trench be closed as soon as possible after the pipe has been laid, installing thrust blocks could be impractical.

**Tip:** Most of these limitations can be over-come by using restrained pipe joints or a combination of restrained pipe joints and thrust blocks.

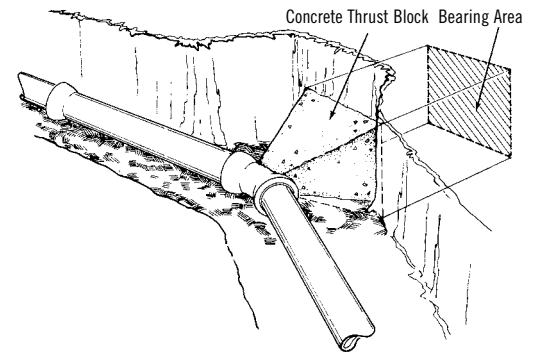
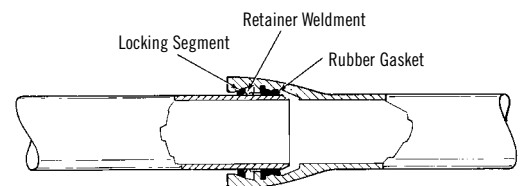

Figure 6: Concrete Thrust Block and Soil Bearing Area

### TR FLEX® Restrained Joint Pipe



TYTON®, TYTON JOINT®, TR FLEX®, FIELD LOK 350®, and MJ FIELD LOK® are Registered Trademarks of U.S. Pipe and Foundry Company.

## Restrained Joint Piping

Another way of resisting thrust forces in a pipeline is to use restrained joints for a calculated length on both sides of bends or other fittings where thrust forces are anticipated. Unlike push-on or mechanical joints, restrained joints have a mechanism that grips, or locks the joint together to prevent axial movement and separation. (See Figure 7). The thrust loads are distributed to the surrounding soil through the lengths of restrained pipe.

Just as the appropriate bearing area must be calculated in designing a thrust block, the required restrained length on both sides of a bend or other fitting must also be determined according to soil and pipeline parameters. Soils with higher bearing capacity and higher internal friction angles require shorter lengths of restrained pipe.

### Importance of Soil Resistance

Thrust forces tend to move the pipeline in the direction of thrust, which may cause the joints to pull apart. In an underground pipeline, the soil provides natural resistance to the pipeline's movement. The magnitude of this resistance depends on the properties of the soil surrounding the pipe.

### Soil Bearing Capacity

The soil bearing against the barrel of the pipe provides resistance to movement of the line. As with thrust blocks, the bearing capacity of the soil and the contact area of the pipe can be used to calculate the magnitude of this resistance.

In thrust block design, the bearing pressure is usually considered to be uniform over the entire bearing surface area. In the DIPRA method for restrained joint design, the bearing area is considered to decrease linearly from the point of the thrust force to the end of the restrained piping. (See Figure 8).

### Frictional Resistance

Soil also offers frictional resistance to the movement of the line. Frictional resistance is a function of the physical properties of the soil as well as the depth of cover, the weight of the pipe, and the weight of the fluid in the pipe. Pipe encased in polyethylene is separated from the soil, which reduces the frictional resistance to thrust.

TYTON JOINT® Pipe with FIELD LOK 350® Gasket

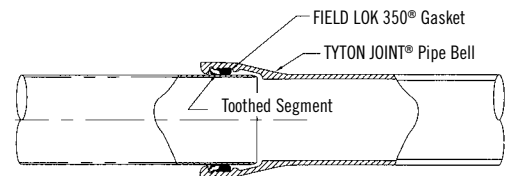

Figure 7: Push-on Restrained Joints

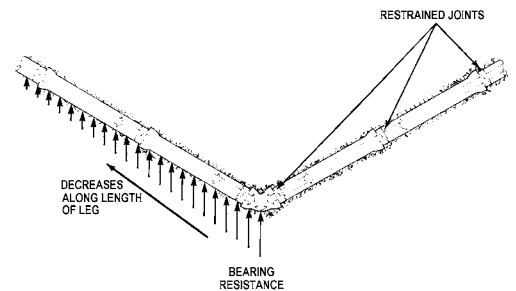
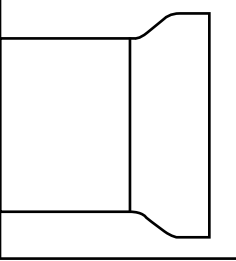

Figure 8: Bearing Resistance of Soil Adjacent to Pipeline





# RESTRAINED JOINTS



2006 EDITION

P 9

## Combining Thrust Blocks and Restrained Joints

### Combining Thrust Blocks and Restrained Joints

Combining restrained joints and thrust blocks in a "belt and suspenders" approach to pipeline thrust restraint helps protect the pipeline against future changes in the supporting soil system.

### The DIPRA Design Method for Length of Restraint

The Ductile Iron Pipe Research Association (DIPRA) has published Thrust Restraint Design for Ductile Iron Pipe,\* a document of conservative design guidelines for the restraint of thrust forces in underground, pressurized, Ductile Iron piping systems. The DIPRA procedures are based on accepted principles of soil mechanics and provide formulas for determining thrust forces and the necessary restraint. In addition to the conservative assumptions inherent in the design procedure, an explicit safety factor is built into each set of calculations to produce designs with adequate overall safety factors. The design engineer has the ultimate responsibility for the proper use of the DIPRA procedures and equations and the selection of appropriate piping products.

*\*Copies of the DIPRA brochure, Thrust Restraint Design for Ductile Iron Pipe, are available from DIPRA or U.S. Pipe.*

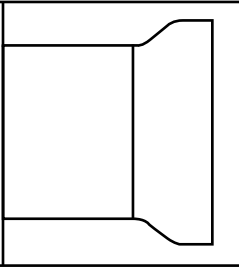

# RESTRAINED JOINTS



2006 EDITION

P 10

## Design Parameters

If the installation conditions of a pipeline are known, the DIPRA design method can normally be used to determine the restrained length of pipe necessary to balance the system's thrust forces. The conditions that must be known include the following:

### 1. Thrust Restraint Design Pressure

The thrust restraint design pressure is often different from the system's design operating pressure. The pipeline designer must decide if the maximum operating pressure, the line test pressure, or the maximum anticipated surge pressure should be used in calculating thrust restraint. The higher the pressure, the more restraint required.

*Tip: Normally the test pressure can be used as the thrust restraint design pressure for most installations.*

### 2. Trench Type

The conditions of the trench in which the pipe is laid effect resistance to thrust forces. The DIPRA design method uses the five standard laying conditions for Ductile Iron pipe established in the ANSI/AWWA C150/A21.50 "Thickness Design of Ductile-Iron Pipe." Thrust restrained lengths can be decreased by improving the quality of the trench. The greater the soil compaction in the trench, the shorter the restrained length required.

*Suggestion: Make sure that a good job of trench compaction is done, particularly next to fittings where thrust forces are anticipated.*

### 3. Depth of Cover

The depth of cover and the combined weight of the pipe and its contents increase the frictional forces between the pipe and the soil. The greater the depth of cover and the density of the soil over the pipeline, the shorter the length of the pipeline that must be restrained to resist thrust forces.

*Suggestion: Above ground lines should be totally restrained.*

### 4. Polyethylene Encasement

Polyethylene encasement, used for corrosion protection, reduces the frictional resistance between the pipe and the soil by approximately one-third. Additional restraint must be calculated for polyethylene-encased portions of a pipeline. This fact is taken into account in the DIPRA design method.

Figure 9: Standard Laying Conditions-Trench Types

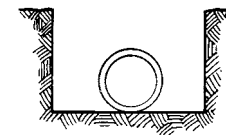

Type 1

Flat-bottom trench (undisturbed earth). Loose backfill. (This trench type provides the least soil resistance.)

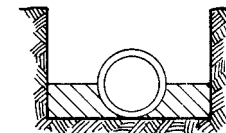

Type 2

Flat-bottom trench. Backfill lightly consolidated to centerline of pipe.

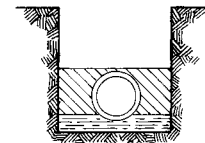

Type 3

Pipe bedded in 4" minimum loose soil. Backfill lightly consolidated to top of pipe.

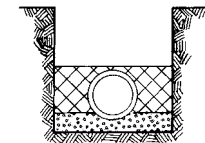

Type 4

Pipe bedded in sand, gravel or crushed stone to depth of 1/8 pipe diameter, 4" minimum. Backfill compacted to top of pipe.

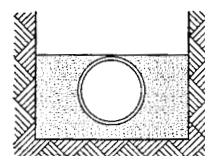

Type 5

Pipe bedded to its centerline in compacted granular material, 4" minimum under pipe. Compacted granular or select material to top of pipe.

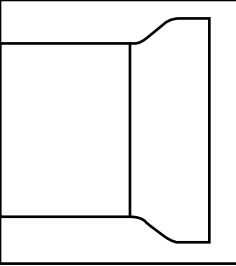

# RESTRAINED JOINTS



2006 EDITION

P 11

## Design Parameters (cont.)

### 5. Type of Fitting

In pressurized pipelines, thrust forces are generated at bends, tees, reducers, caps, plugs, and valves. The magnitude of the force depends on the type of fitting and other factors, such as the angle of the bend, pipe diameter, and the operating pressure of the line.

**Suggestion:** To minimize thrust loads, minor changes of direction should be made gradually, using the smallest practical degree bend. Changes of direction can often be made without any joint restraint by using the allowable deflection of push-on TYTON JOINT® Pipe.

### 6. Vertical Bends

Vertical bends require particular care. Trench compaction on the steep grades associated with the use of a vertical bend is usually not as good as trench compaction on relatively flat sections. If the trench condition is expected to be poor, additional restrained joints should be provided. All push-on joints before and after the bend should be fully extended. If FIELD LOK 350® Gaskets, TR FLEX® Pipe and Fittings or TR FLEX GRIPPER® Rings are used in a vertical installation, provisions must be made to keep the joint permanently extended and not allow slack to develop. Failure to keep vertical joints extended can result in joint separation. Additional restraint is usually required for vertical bends since the thrust force acts upward against the recently backfilled trench soil.

**Suggestion:** Smaller degree bends should be used for higher pressure, larger diameter vertical bend installations to minimize the lateral thrust forces. For vertical bends, to maximize the soil resistance, proper soil compaction should be attained. Care should be taken to compact the trench thoroughly, particularly on the downward slope of the trench where compaction may be more difficult.

### 7. Soil Properties

In the DIPRA method, soil types have been divided into seven broad categories based on the ASTM D 2487 Soil Classification Chart. Each of the seven soil categories has been assigned conservative bearing capacity and frictional resistance values.

**Suggestion:** Given the wide variations in soil conditions, soil tests should be made to ensure that the appropriate design parameters are chosen.

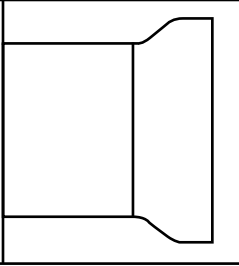

# RESTRAINED JOINTS



## Thrust Restraint Calculation Assistance

With the many different factors involved, calculating the necessary restrained lengths for a pipeline can be time-consuming. The DIPRA brochure is on their website ([www.dipra.org](http://www.dipra.org)), but the most efficient way to figure thrust restraint requirements is through a computer program developed by DIPRA. Computerized assistance with thrust restraint calculations is downloadable from the DIPRA website and is available through U.S. Pipe Sales Representatives.

*Tip: Using DIPRA's computer program, projections and analysis can be made comparing different degree bends, trench types, and other conditions to achieve the safest design for the least cost.*

### Information Required for Thrust Restraint Calculations

This form may be used to furnish your U.S. Pipe representative with the information required for thrust restraint calculations.

CUSTOMER NAME:

JOB or QUOTE NUMBER:

JOB SITE:

SALESMAN:

SOIL TYPE:

PIPE CLASS:

HIGHEST PRESSURE:

DEPTH OF COVER:

FITTING TYPE:

If tee is the fitting type, then indicate length of pipe section on either side of the run. Otherwise forty (40) feet will be assumed. If the fitting type is bend, then indicate:

HORIZONTAL

VERTICAL UP

VERTICAL DOWN

Thrust restraint for true wyes or wye branches are not calculated using this program.

NOMINAL SIZE:

POLYWRAP or BARE:

TRENCH TYPE:

Figure 10: Sample from DIPRA's Thrust Restraint Program

### Ductile Iron Pipe Research Association

#### Thrust Restraint Analysis For Ductile Iron Pipe

Type of Fitting	:	BEND
Angle of Bend	:	11.25 degrees
Diameter of Bend	:	24 inches
Orientation of Bend	:	HORIZONTAL
Laying Condition	:	Type 4
Soil Designation	:	COH-GRAN
Depth of Cover	:	3 feet
Design Pressure	:	150 psi
Safety Factor	:	1.50

#### The Length of Restrained Joint Piping for each side of the Bend is:

- 6 feet (bare pipe)
- 7 feet (polywrapped pipe)

## Restrained Joint Pipe and Fittings

Popular types of boltless, restrained joints have been developed by U.S. Pipe: TR FLEX® Pipe and Fittings, FIELD LOK 350® Gaskets and MJ FIELD LOK® Gasket. Boltless designs have several advantages over traditional, bolted restrained joints: greater flexibility, fewer components, and easier installation.

### TR FLEX Pipe and Fittings

TR FLEX Pipe and Fittings are available in a range of sizes from 4" – 64". Joint separation is prevented by inserting Ductile Iron locking segments through a slot in the pipe or fitting bell. The locking segments engage a weldment or bead around the plain end of the pipe, and the joint is sealed with a TYTON JOINT® Gasket in the 4" – 42" sizes and a TR FLEX® Gasket in the 48" – 64" sizes.

All TR FLEX Pipe, Fittings, and locking segments are made of Ductile Iron. There are right and left hand segments for sizes 4" – 36". One right hand and one left hand segment is inserted through each slot.\* From two to eight segments are utilized per joint depending on pipe and fitting size. TR FLEX Pipe and Fittings in sizes 42" – 64" have only one insertion slot for segments. Eleven identical locking segments are used for these sizes.

*\*There are two slots in the 4" – 10" sizes, however, only one slot is used for segment insertion.*

### Wedging Action For Sizes 4" – 36"

TR FLEX Pipe and Fittings are restrained with a unique wedging action. The locking segments act as wedges between the inner surface of the pipe or fitting bell and the outer surface of the plain end to prevent the joint from separating.

The locking segments of sizes 4" – 36" have a spherical outer surface, which mates with a similar surface inside the pipe or fitting bell. The spherical surfaces permit deflection of the components while maintaining full engagement around the joint.

### Wedging Action For Sizes 42" – 64"

A wedging action similar to that of the smaller sizes is utilized on the 42" – 64" sizes, however, rather than having a spherical surface between the inner bell and locking segments the surface is at a slight incline with a stop at the rear of the segment to restrict the radial force on the pigot of the joining pipe.

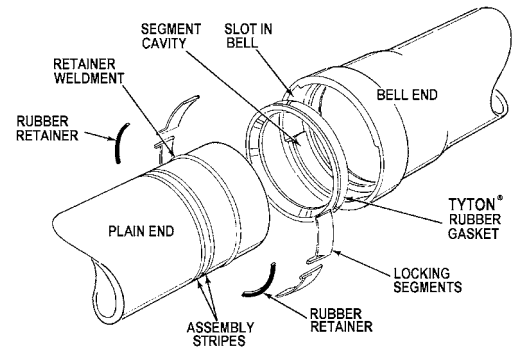
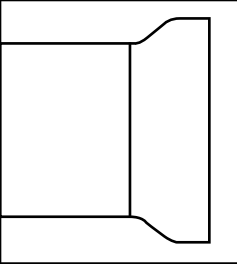

Figure 12: TR FLEX® Pipe - Typical 4" – 36" Sizes



# RESTRAINED JOINTS



## Restrained Joint Pipe and Fittings (cont.)

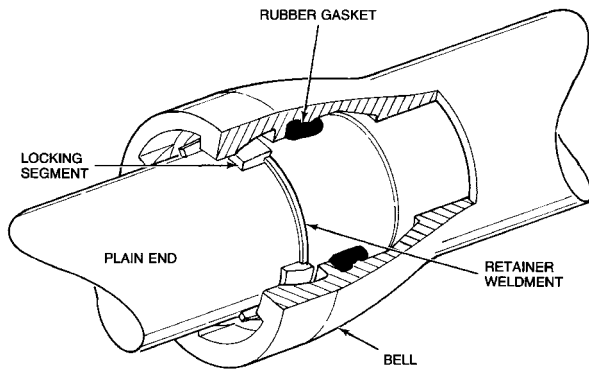

Figure 13: Assembled TR FLEX® Pipe Joint - Typical 4" - 36" Sizes

- $F_A$  = axial force (thrust)
- $D$  = pipe diameter, inches
- $F_R$  = radial force
- $P$  = pressure, psi
- $F_N$  = normal force
- $\alpha$  = contact angle of locking segment
- $F_F$  = frictional force
- $\mu$  = coefficient of friction of ductile iron = .025
- $F_W$  = force of the weld

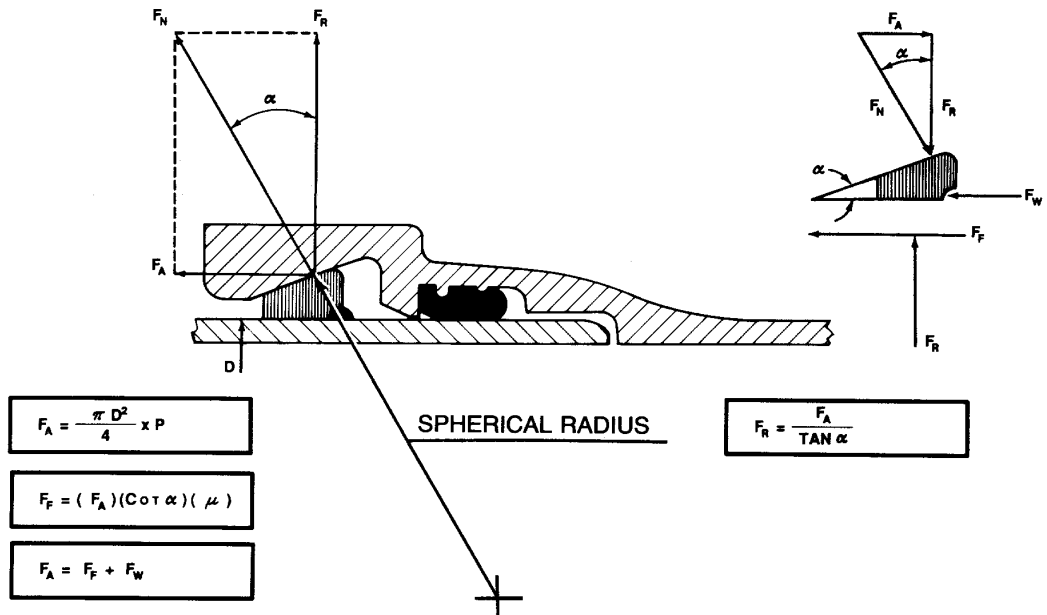
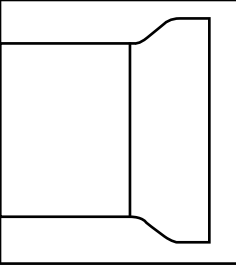

Figure 14: Force Diagram for TR FLEX® Pipe Joint - Typical 4" - 36" Sizes



# RESTRAINED JOINTS



2006 EDITION

P 15

## TR FLEX® Pipe and Fittings

### Frictional Force Reduces Weld Loads

As the locking segments are wedged between the bell and the plain end, they push out on the inside of the bell socket. Simultaneously, an equal, opposing force is imparted from the bell to the locking segments creating a frictional force between the locking segments and the plain end of the pipe. The frictional force reduces the amount of the axial thrust force transmitted to and carried by the retainer weldment.

### Strength of Shop-Applied Weldments

A bead is applied to the plain end of TR FLEX Pipe at the factory by automatic MIG (metal inert gas) wire welding. The welding procedure, welders, and welding operators are qualified and certified in accordance with the Structural Welding Code ANSI/AWS D1.1.

The weldments have shear strengths of more than 20,000 pounds-force per inch of weld length. The weld has a safety factor of greater than 5:1 at the joint rated pressure. Taking into account the effect of the design's frictional loading, the weldment is subjected to much lower stresses than in conventional weldment-restrained pipe joints.

### Joint Flexibility

Another advantage of the TR FLEX Pipe and Fittings design is the flexibility of the joint. Due to the shape of the contact surfaces on the outside of the locking segments and the inside surfaces of the bell socket, joints can be deflected and the locking segments remain fully engaged. The joint deflects in the same manner as a ball and socket joint.

TR FLEX Pipe and Fitting joints retain their flexibility even after installation. The joint remains secure even when the earth settles or the pipeline moves.

### Ease of Installation

TR FLEX Pipe and Fittings can be assembled and installed with the same tools used to assemble push-on joint pipe and fittings. The 54" TR FLEX Pipe joint has been assembled in the field in less than two minutes.

To disassemble TR FLEX Pipe and Fittings, come-a-longs or assembly tools are used to "re-home" the joint, then the locking segments are removed. The joint can be reassembled and used again, although replacing the rubber gasket is recommended. The ease of disassembly also makes TR FLEX Pipe and Fittings especially suited for temporary applications, such as above ground bypasses and irrigation systems.

### Special Gaskets for Larger Joints

All TR FLEX Pipe and Fittings 42" size and smaller use conventional TYTON JOINT® Gaskets, the same ones used in push-on TYTON JOINT® Pipe and TYTON JOINT® Fittings. The TR FLEX® Gaskets used in the 48" – 64" TR FLEX Pipe and Fittings are similar, but not identical to the conventional TYTON JOINT® Gaskets for these sizes. They are not interchangeable.

### Design Deflection

SIZE Inches	MAX DEFLECTION Degrees
4	5°
6	5°
8	5°
10	5°
12	5°
14	3-1/4°
16	3-1/4°
18	3°
20	2-1/2°
24	2-1/4°
30	1-3/4°
36	1-1/2°
42	1/2°
48	1/2°
54	1/2°
60	1/2°
64	1/2°

**Figure 18:** This table shows the normal deflection that can be obtained at each pipe joint

## TR FLEX® Pipe and Fittings (cont.)

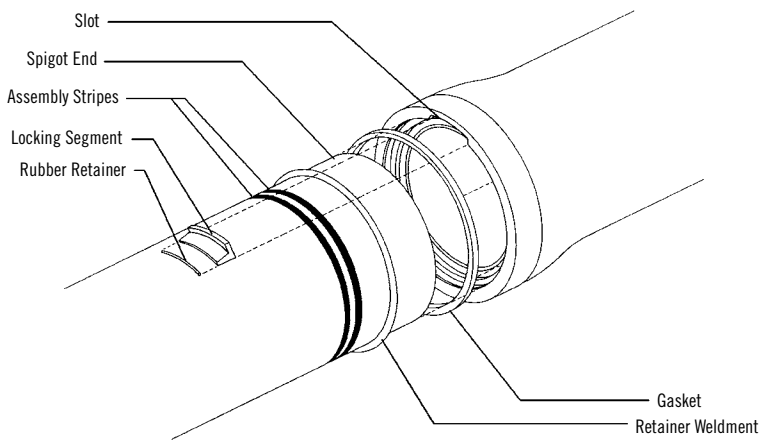

Figure 15: TR FLEX® Pipe - Typical 42" – 64"

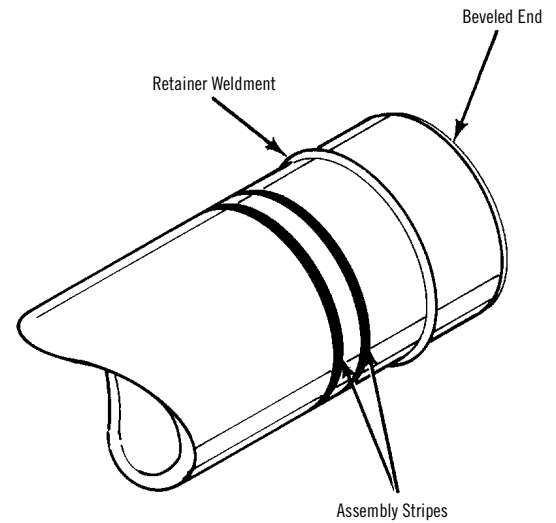
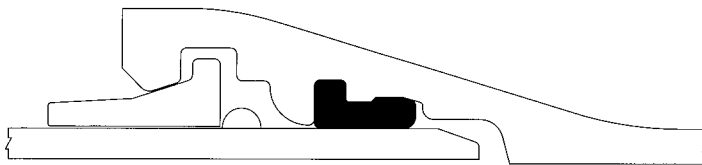

Figure 17: Plain (Spigot) End TR FLEX® Pipe

### 42" & 48" TR FLEX® Pipe and Fittings



### 54", 60", & 64" TR FLEX® Pipe and Fittings

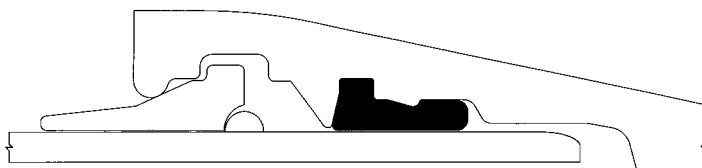

Figure 16: TR FLEX® Pipe and Fittings 42" uses a standard TYTON JOINT® Gasket. 48" – 64" uses a special TR FLEX® Gasket.





## Field Cuts — TR FLEX GRIPPER® Ring

TR FLEX® Pipe can be cut in the field with an abrasive saw. The cut end must be beveled in the same manner as TYTON JOINT® Pipe. Any 4" to 36" diameter TR FLEX Pipe that has been cut in the field or does not have a weldment on the plain end can be restrained with a TR FLEX GRIPPER® Ring. See Figure 25 on page 24 for acceptable dimensions before making cut.

The TR FLEX GRIPPER® Ring is a set of Ductile Iron locking ring segments with hardened stainless steel teeth on the inner surfaces. They replace the weld bead, the locking segments and the rubber retainers. The ring segments are placed inside the TR FLEX® Pipe or Fitting bell lug cavity before the plain end is inserted into the bell. The ring segments are bolted end to end to clamp the ring around the pipe barrel. Radial wedging forces from the bell embed the teeth in the wall of the plain end to prevent the joint from separating. No retainer weldment is needed to restrain the joint. Joints restrained with TR FLEX GRIPPER Rings have the same pressure rating as conventional TR FLEX Pipe and Fitting joints.

TR FLEX GRIPPER Rings are available for 4" – 36" pipe sizes. For 42" – 64" pipe, a field weldment must be applied to the field cut pipe end.

**Suggestion:** TR FLEX GRIPPER Rings should be installed in pipe sockets rather than fitting sockets where feasible, since it is easier to keep the pipe-to-pipe joint in alignment during assembly.

Figure 20 shows how this can be done when a pipe is cut for installation of a fitting. A field cut is made to a TR FLEX Pipe at the desired location. The plain end with the factory weld bead (A) is installed into one end of the TR FLEX Fitting and restrained with conventional TR FLEX locking segments. The field cut and beveled plain end (B) is installed into the bell of the preceding pipe and restrained with a TR FLEX GRIPPER Ring. A full length TR FLEX Pipe is then installed into the other socket of the TR FLEX Fitting and restrained with locking segments. The remaining bell by plain end cut piece is then installed into the socket of the full length TR FLEX Pipe with a TR FLEX GRIPPER Ring. Laying continues with conventional TR FLEX Pipe.

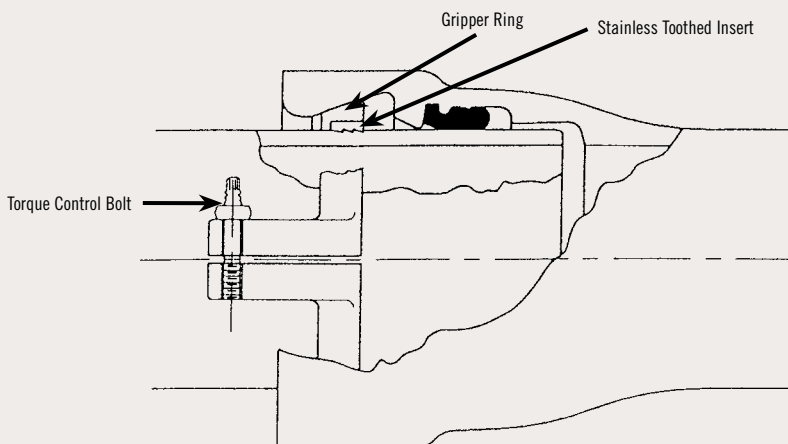
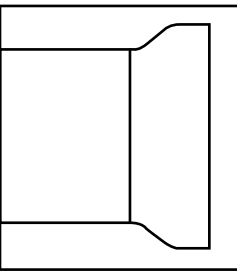

Figure 19: TR FLEX GRIPPER Ring



Figure 21: TR FLEX GRIPPER Ring Installation

Call your U.S. Pipe Sales Representative for the brochure on the complete assembly and installation instructions.



# RESTRAINED JOINTS



## Field Cuts — TR FLEX GRIPPER® Ring (cont.)

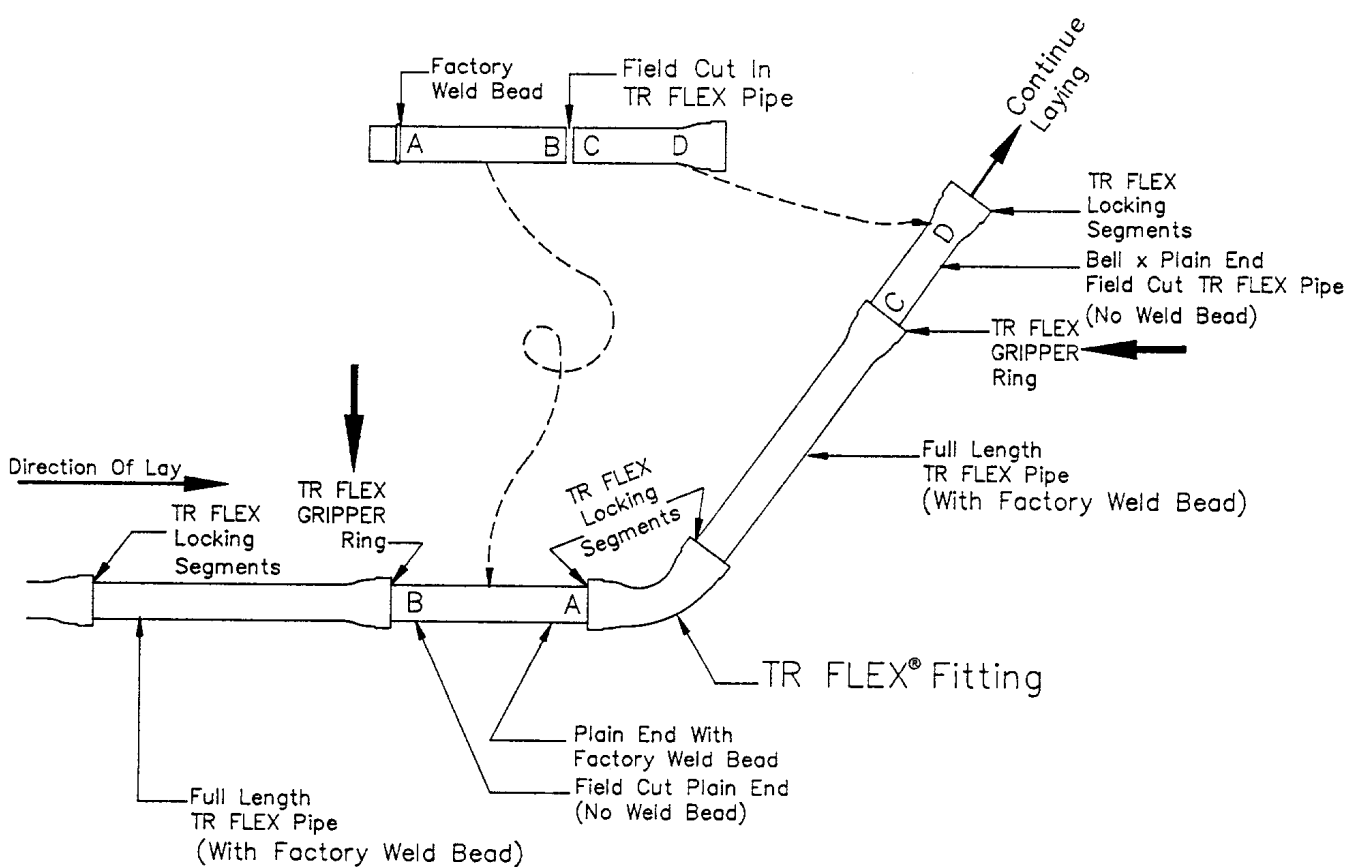
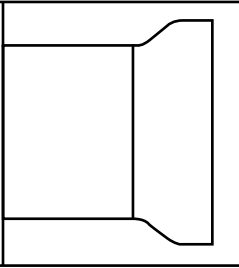

Figure 20: TR FLEX GRIPPER Ring Installation Example



# RESTRAINED JOINTS



2006 EDITION

P 19

## TR FLEX® Pipe and Fittings

### Field Welding

Field weldments are required for field-cut 42" – 64" diameter TR FLEX Pipe. If desired, field weldments can also be applied to smaller diameter pipe.

A field weldment is made by welding a round steel bar to the pipe. Prior to the welding operation, the bar is formed to fit the pipe outer diameter. The bar is located the same distance from the end of the pipe as the shop-applied weld bead. The joint with the field weldment is assembled in the same manner as the conventional joint with a shop-applied weld bead using conventional TR FLEX locking segments. Instructions for cutting and welding TR FLEX Pipe in the field are given in the U.S. Pipe's Field Cutting and Welding Procedure for TR FLEX Pipe brochure.

### Fittings

The TR FLEX Fitting joint design is the same as the TR FLEX Pipe joint, so the same gaskets and locking segments are used for both pipe and fittings.

### TR FLEX® Telescoping Sleeves

The TR FLEX Telescoping Sleeve is a fitting that can be used to tie together two sections of restrained pipe. A telescoping sleeve assembly normally consists of a bell and plain end TR FLEX® Pipe and a plain end and plain end TR FLEX Pipe, both inserted into the sleeve. Plain end pipe can be telescoped into the sleeve approximately 16 inches (two socket depths). When the sleeve assembly is contracted, it can be placed between the fixed ends of two restrained pipes, then extended to connect the joints on both ends.

The TR FLEX Telescoping Sleeve uses the same gasket and locking segment configurations as a conventional TR FLEX Pipe and Fitting joint. However, the plain ends inserted into the sleeve require special weld bead locations.

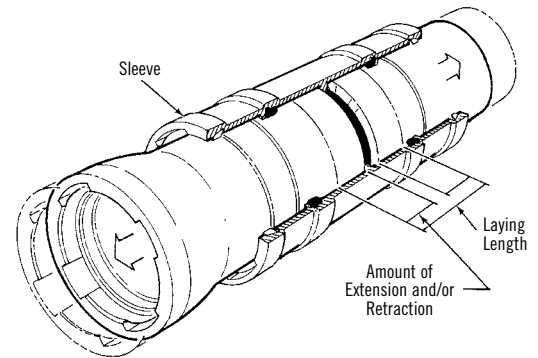
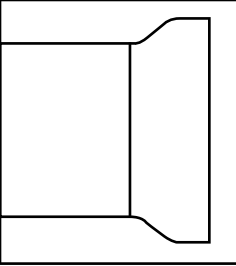

Figure 22: TR FLEX Telescoping Sleeve assembly

**NOTE:** The TR FLEX Telescoping Sleeve can also be used to replace damaged pipe in a restrained section of a line or to provide expansion capability where extreme soil movement or settling is anticipated.



# RESTRAINED JOINTS



2006 EDITION

P 20

## TR FLEX® Pipe and Fittings (cont.)

### XTRA FLEX® Couplings

The XTRA FLEX Couplings can provide a high degree of deflection when used in conjunction with the TR FLEX® Piping system. The coupling consists of a sleeve and two reducers and can provide approximately 4 times the deflection of a single TR FLEX Pipe joint. This joint is ideally suited for use in earthquake prone areas or areas where there may be unstable soil.

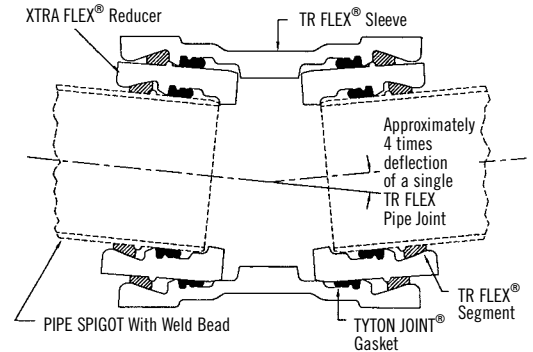

### TR TELE FLEX® Assembly

The TR TELE FLEX Assembly combines the features of the Telescoping Sleeve and the XTRA FLEX Assembly to provide a unit which provides deflection and extension with joint restraint.

The TR TELE FLEX Assembly, which utilizes two XTRA FLEX Couplings and one Telescoping Sleeve, is well suited for use in areas where ground movement may result from unstable soil conditions or in earthquake prone areas.

Typical use of the TR TELE FLEX Assembly may include: Connecting pipelines to pump stations or water storage tanks.

The TR TELE FLEX Assembly is produced in sizes 4"–24" and is shipped preassembled.

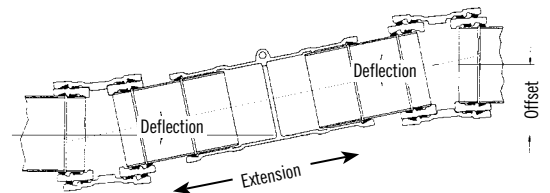

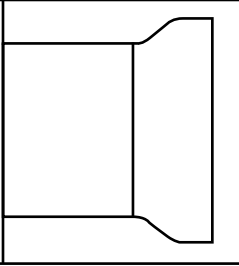

# RESTRAINED JOINTS



2006 EDITION

P 21

## Specifications for TR FLEX® Pipe and Fittings

### Rated Operating Pressure

TR FLEX® Pipe and Fittings are rated for operating pressures of 350 psi in the 4" – 24" sizes and 250 psi in the 30" – 48" diameters. 54" – 64" are rated for 150 psi. Representative sizes have been tested in both straight and deflected positions to at least twice the rated pressure. To determine the suitability of TR FLEX Pipe and Fittings for higher operating pressures, or to obtain a certified copy of test reports, please contact your U.S. Pipe Sales Representative.

### Listed by Underwriters Laboratories, Inc.

Underwriters Laboratories, Inc. lists the 4" – 12" TR FLEX Pipe and Fittings for use up to 350 psi operating pressures. Some fire protection systems may require the use of UL-listed products.

### Approved by Factory Mutual Research

Factory Mutual Research requires testing at four times the rated pressure and has approved TR FLEX Pipe and Fittings in sizes 4" – 12" for 250 psi rating. TR FLEX GRIPPER® Rings are FM approved for 200 psi rating in this size range.

### Joint Clearance

Internal clearance is required between the joint components to allow for insertion of the locking segments in TR FLEX® Pipe and Fitting joints. The amount of this clearance varies due to the tolerance of the components. For sizes through 36" diameter, this clearance varies up to about 5/8". For the 42" – 64" size, the clearance can vary up to approximately 1-1/8 inches.

It is important to fully extend the joints during installation to remove the clearance or slack in the joint. This slack is built into the joint to allow easy insertion of the locking segments. If the slack is not removed during installation by pulling on each pipe after it's connection to the pipeline is made, the thrust forces generated by the hydrostatic pressure in the line will tend to extend the line once in service. Although the joints will not separate, considerable growth in the overall line length may result. For example, in a restrained large diameter line 400 feet long, and assuming none of the joints have been extended to remove the slack condition, then a potential growth of 1 1/8 inches per joint can be expected. If each pipe averages 18 feet in lay length, then there will be approximately 22 joints in the line so the entire line may grow by nearly 2 feet in length. This is generally an unacceptable condition for most installations and may result in significant damage to the pipeline installation or surrounding structures.

A slight movement of the pipe and fittings due to elongation is not detrimental in most underground pipelines. In situations where the pipeline itself carries most or all of the thrust forces, the restrained joints should be completely extended during installation. This includes above ground pipelines such as bridge crossings, pipelines in areas with poor soil conditions, and extremely long restrained sections of TR FLEX Pipe and Fittings.

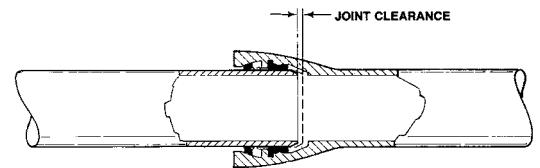
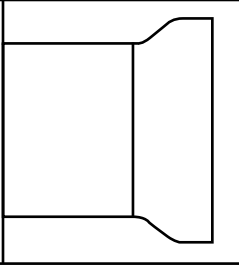

Figure 23: Possible Extension in Joint of TR FLEX Pipe and Fittings Due to Joint Clearance



# RESTRAINED JOINTS



2006 EDITION

P 22

## Specifications for TR FLEX® Pipe and Fitting (cont.)

### Pipe in a Casing

Installing restrained joint pipe through an outer casing pipe is often necessary. If the pipe inside the casing is subject to thrust forces, the restrained joints should be fully extended before the ends are connected. It is recommended that restrained joint pipe be pulled through the casing — not pushed — to keep the joints extended.

*Tip: A rubber retainer is provided to retain the locking segments for normal installations. Steel rods may be welded between the handles of the locking segments to provide additional retention when restrained sections of line are to be pulled or installed per instructions for securing locking segments as described in the U.S. Pipe's Horizontal Directional Drilling brochure.*

The length of restrained pipe inside the casing should not be considered as part of the restrained length required to balance the thrust force because no frictional forces are transferred to the soil.

### Unstable Soils

In swamps or marshes where the soil is unstable, or in other situations where the bearing strength of the soil is extremely poor, the entire pipeline should be restrained to provide adequate thrust restraint.

### Underwater Installations

TR FLEX® Pipe and Fittings can be used in underwater installations when the underwater terrain is reasonably level. The pipe can be preassembled in sections to simplify the installation process, if adequate rigging is used to lift and lower the pipe. However, when the bottom terrain is not level or the pipe will be subjected to extreme joint deflection for any reason, USIFLEX® Pipe should be used. USIFLEX Pipe can be deflected up to 15° at each joint with a 12° design limitation recommended. It is recommended for most river crossings and underwater applications.

### Above Ground Lines

Above ground pipelines, such as by-passes or bridge crossings, can be totally restrained so that the pipeline itself carries the thrust load. TR FLEX Pipe and Fittings are appropriate for such lines. Because bridge crossing lines are usually several hundred feet in length, fully extending the restrained joints during installation to prevent elongation when the lines are pressurized is important.

Many bridge crossings occur in swamp or marshlands near a sea coast. Both the soil and trench conditions on either side of the bridge are likely to be very poor, requiring additional restrained length. Vertical bends and offsets required to change the direction of the line at both ends of the bridge also necessitate additional restraint. The smallest possible degree bend should be used to make the offsets at each end of the bridge. All restrained joints should be fully extended before pressurizing the line. Each length of pipe must be supported in a manner to restrict both vertical and horizontal movement.

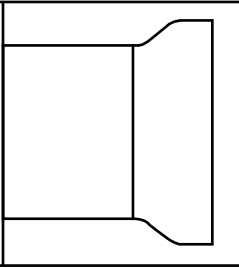

# RESTRAINED JOINTS



2006 EDITION

P 23

## FIELD LOK 350® Gaskets

U.S. Pipe also produces the FIELD LOK 350 Gasket boltless restrained joint system for use with conventional TYTON JOINT® Pipe and Fittings. FIELD LOK 350 Gaskets are made for sizes 4" – 24".

The gasket elastomer is the same material used for TYTON® Gaskets. The locking segments are produced from a special grade of corrosion-resistant, hardened, stainless steel. The segments are vulcanized into the rubber gasket.

### Ease of Assembly

Joints with FIELD LOK 350 Gaskets are assembled in the same manner as conventional push-on joints. The gasket and gasket seat must first be inspected for cleanliness, then the gasket is inserted and seated evenly in the gasket seat of the socket.

**Suggestion:** When looping the gasket for insertion, make the loop in the rubber between two locking segments, to minimize the stress on the bond between the segments and the rubber.

TYTON JOINT® Lubricant is applied to the gasket surface that will come into contact with the entering pipe. Lubricant is also applied to the plain end of the pipe. In warm, dry weather conditions, the lubricant can dry out, especially when applied to warm or hot pipe, it will be necessary to add a small amount of water to hydrate the lubricant. Only TYTON JOINT Lubricant should be used.

**Caution:** The use of spray-on lubricant is not recommended. Experience has determined that spray-on lubricant may not have sufficient lubricity to allow joint assembly without gasket displacement.

The plain end of the pipe is aligned, inserted in the bell socket until it touches the gasket, then pushed into the socket. After the joint is pushed together, it should be pulled apart slightly to ensure that the teeth of the locking segments bite into the pipe.

### Field Cuts

FIELD LOK 350 Gaskets are ideal for making restrained joints with field cut pipe. No welding or other special procedure is required. The plain end of the pipe must be square cut and beveled. The FIELD LOK 350 Gasket is installed in the conventional manner.

**Suggestion:** Measure the diameter of the pipe with either a diameter (Pi) tape or a conventional tape at the location of the cut to ensure that the pipe barrel will fit into the socket of the joining pipe or fitting.

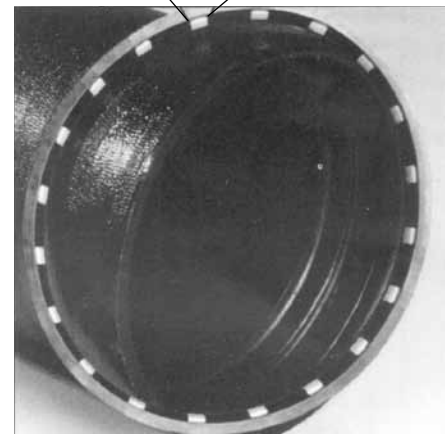
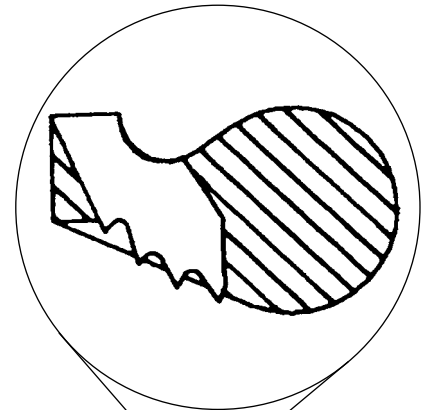
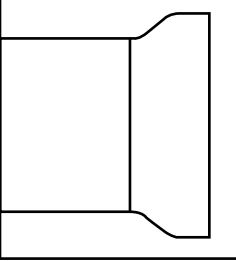

Figure 24: FIELD LOK 350 Gasket

**NOTE:** The FIELD LOK 350 Gasket is recommended for buried service only.

**THICK COATINGS OR TAPE WRAP** - The FIELD LOK 350 Gasket should not be used on pipe which have thick coatings or tape wrap on the outer diameter of the pipe. In general, if the peen pattern is not visible on the pipe surface, the coating may be too thick for proper penetration of the teeth of the FIELD LOK 350 Gasket. The thick coating should be removed from the end of the pipe before assembly. The coating must be no more than 6 mils thick on the plain end of the pipe.



# RESTRAINED JOINTS



2006 EDITION

P 24

## FIELD LOK 350® Gaskets — Pipe Diameters and Circumferences for Joints

Figure 25: Pipe Diameters and Circumferences for Joints with FIELD LOK 350 Gaskets

SIZE Inches	MAX. O.D.	MIN. O.D.	CIRCUMFERENCE		MAXIMUM ANGLE Degrees	DEFLECTION*			LOCATION OF ASSEMBLY MARK
			MAXIMUM	MINIMUM		INCHES AT 18'	MAXIMUM ANGLE Degrees	INCHES AT 20'	
4	4.86	4.74	15-9/32	14-7/8	5	19	—	—	2-3/4
6	6.96	6.84	21-7/8	21-15/32	5	19	—	—	2-15/16
8	9.11	8.99	28-5/8	28-1/4	5	19	—	—	3-1/4
10	11.16	11.04	35-1/16	34-11/16	5	19	—	—	3-5/16
12	13.26	13.14	41-21/32	41-9/32	5	19	—	—	3-5/16
14	15.35	15.22	48-7/32	47-13/16	4	15	—	—	4-9/16
16	17.45	13.32	54-13/16	54-13/32	4	15	5	21	4-9/16
18	19.55	19.42	61-13/32	61	4	15	—	—	4-9/16
20	21.65	21.52	68-1/32	67-19/32	2.5	9	5	21	5-1/16
24	25.85	25.72	81-7/32	80-25/32	2.5	9	5	21	5-1/2

O.D. = outside diameter

\* The pipe to be installed must be kept in straight alignment with the previously installed pipe or fitting during assembly. Joint deflection may be made after completion of assembly. If the joint is to be deflected, it should not be fully homed leaving approximate 3/8" gap in the socket. After assembly, the joint can be deflected.



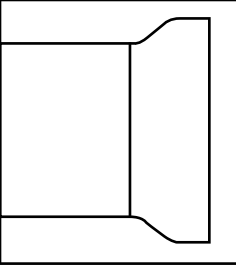

# RESTRAINED JOINTS



2006 EDITION

P 25

## FIELD LOK 350® Gaskets

### Assembly Stripes

When assembling field-cut pipe, an assembly mark should be made on the cut end of the pipe. The use of the assembly mark helps ensure that the pipes plain end is inserted the proper depth into the socket. If the plain end is inserted too far, joint deflection will be limited.

*Tip: The painted assembly stripes on a factory length of pipe can be used as a marking guide.*

### Installation Inspection Methods

The assembled FIELD LOK 350 Gasket joint can be inspected by trying to separate the joint and by checking the position of the assembly stripes on the plain end.

*Tip: A feeler gauge can be inserted in the gap between the outside of the plain end and the inside of the bell to 'feel' the positioning of the gasket.*

### Disassembly Possible for Most Cases

FIELD LOK 350 Gasket joints can normally be disassembled with special shims available from U.S. Pipe. Extremely tight joints may have to be cut apart. In either case, the gasket should not be reused. The assembly tools can also be used for disassembly.

*Suggestion: If disassembly and reassembly are anticipated, TR FLEX® Pipe and Fittings should be used instead of FIELD LOK 350 Gaskets.*

### Joint Deflection

FIELD LOK 350 Gasket joints are designed to deflect up to 5° in the 4" – 12" sizes, 4° in the 14" – 18" sizes and 2-1/2° in 20" – 24" sizes. Joint deflection should be set after the joint has been assembled.

### Rated Operating Pressure

The FIELD LOK 350 Gasket is rated for operating pressures up to 350 psi for sizes 4" – 24", 30" and 36" FIELD LOK® Gaskets are rated for operating pressures up to 250 psi. All sizes of the FIELD LOK Gasket have been tested in joints at the maximum and minimum allowable tolerance range to at least 2 times the rated pressure without failure.

### Underwriters Laboratories, Inc. Listing and Factory Mutual Research Approval

4" – 16" FIELD LOK 350 Gaskets are listed by Underwriters Laboratories for operating pressures up to 350 psi, and Factory Mutual for 250 psi (4:1 safety factor).

18" – 24" FIELD LOK 350 Gaskets are listed by Underwriters Laboratories for operating pressures up to 350 psi, and Factory Mutual for 200 psi.

**NOTE:** If the pipe is bottomed out (inserted too far) in the socket, joint deflection will be restricted. Insert the pipe only until the first assembly stripe is inside the bell face.

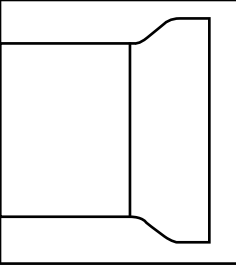

# RESTRAINED JOINTS



2006 EDITION

P 26

## MJ FIELD LOK® Gasket

Forget those heavy lug-type restraints and switch to the new MJ FIELD LOK® Gasket. It not only seals, but also provides the joint restraint that typically requires concrete thrust blocks or lug-type restraints outside the joint. That means you'll have fewer installation steps, with faster and easier installations.

Two primary components make up the MJ FIELD LOK Gasket. The first, an elastomeric material, does the sealing. The second, either stainless steel locking segments (Series DI) or a ductile iron locking ring (Series PV), are the teeth that give MJ FIELD LOK its bite. Embedded in the elastomeric material, they lock in to the pipe and provide joint restraint when the pipe system is internally pressurized.

There's no learning curve either. Install it just like a standard mechanical joint gasket. The joint is automatically restrained when the MJ FIELD LOK™ Gland bolts are tightened.



MJ FIELD LOK® Gasket  
Series PV

MJ FIELD LOK™ Gland

MJ FIELD LOK® Gasket  
Series DI

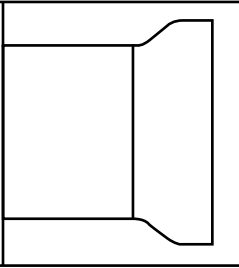

# RESTRAINED JOINTS



2006 EDITION

P 27

## MJ FIELD LOK® Gasket (cont.) Product Overview

- Proven joint restraint technology.
- No learning curve — installs just like a standard mechanical joint gasket and gland.
- No more need for time-consuming thrust blocks or heavy lug-type restraints.
- No loose wedges or torque-off control nuts to get lost or broken.
- Can be disassembled just like a standard mechanical joint.
- Suitable for potable water and wastewater applications.
- The state-of-the-art MJ FIELD LOK™ Gland is designed for maximum strength and easy product identification.
- MJ FIELD LOK® Gaskets are provided as part of a kit that also includes the MJ FIELD LOK-1 pt Gland, nuts and bolts.

### MJ FIELD LOK® Gasket Series DI

Can be used on any Pressure Class or Special Thickness Class Ductile Iron pipe up to 350 psi.  
Stainless steel locking segments provide proven joint restraint technology.

### MJ FIELD LOK® Gasket Series PV

Can be used on any thickness class of AWWA C900 PVC pipe.  
Pressure rated at a 2:1 safety factor, based on the pressure rating of the pipe on which it is installed.  
Ductile iron locking ring provides proven joint restraint technology.

### MJ FIELD LOK™ Gland

Highly engineered to provide the strength and rigidity necessary for restrained joint applications.  
Installs just like a standard mechanical joint gland.  
All ductile iron components are manufactured to ASTM A536 Grade 70-50-05.

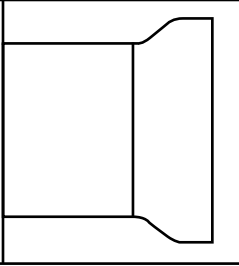

# RESTRAINED JOINTS



2006 EDITION

P 28

## MJ FIELD LOK® (cont.)

### Application Notes

1. MJ FIELD LOK® Gaskets are designed to seal and restrain a centrifugally cast ductile iron or PVC pipe spigot in either a ductile iron pipe or a ductile iron fitting bell.
2. FIELD LOK Gaskets are available to fit mechanical joints conforming to AWWA C110 or AWWA C153 in 4" – 12" sizes.
3. If ductile iron pipe with a lower pressure rating is used, then the lower pressure rating will apply to the MJ FIELD LOK Gasket also.
4. MJ FIELD LOK Gaskets require 90 ft-lb of bolt torque for 4" – 8" gaskets, and 120 ft-lb of bolt torque for 10" – 12" inch gaskets. Most common 1/2" drive air powered impact wrenches are capable of applying these torques.
5. MJ FIELD LOK Gaskets are suitable for either potable water or wastewater applications.
6. MJ FIELD LOK Gaskets are NSF approved with UL and FM certifications pending.
7. MJ FIELD LOK Gasket Series DI products are not recommended for use with cast iron pipe, plastic pipe, oversize pipe, metric pipe, or for use as a 'transition' gasket.
8. MJ FIELD LOK Gasket Series PV products are not recommended for use with cast iron pipe, ductile iron pipe, oversize pipe, metric pipe, or for use as a 'transition' gasket.
9. MJ FIELD LOK Gaskets are warranted only when used with either an MJ FIELD LOK™ Gland or an ANSI/AWWA C110/A21.10 mechanical joint gland.

### Suggested Specifications:

Joint restraint for mechanical joint pipe and fittings shall be the MJ FIELD LOK® Gasket. The restraint system shall be completely integral to the gasket, requiring only standard mechanical joint assembly techniques. The restraining system for ductile iron shall be pressure rated to 350 psi in sizes up to and including 12". The restraining system for PVC shall be rated at a 2:1 safety factor for the pipe on which it is installed. The restraining system shall be rated in accordance with the performance requirements of ANSI/AWWA C111/A21.11 Rubber Gasket Joints for Ductile-Iron Pressure Pipe and Fittings.

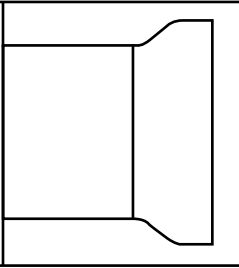

# RESTRAINED JOINTS



2006 EDITION

P 29

## MJ FIELD LOK® Gasket Performance and Dimensions

### MJ FIELD LOK® Gasket Series DI

SIZE Inches	PIPE OD	ORDER NUMBER	NO. OF SEGMENTS	PRESSURE RATING	APPROX. KIT WEIGHT	MAXIMUM DEFLECTION
4	4.80	DI04	3	350	7.3	5°
6	6.90	DI06	4	350	10.9	5°
8	9.05	DI08	6	350	13.5	5°
10	11.10	DI10	9	350	18.5	3°
12	13.20	DI12	13	350	19.7	3°

### MJ FIELD LOK® Gasket Series PV

SIZE Inches	PIPE OD	ORDER NUMBER	PRESSURE RATING DR-18 psi	PRESSURE RATING DR-14 psi	APPROX. KIT WEIGHT
4	4.80	PV04	150	200	7.8
6	6.90	PV06	150	200	11.8
8	9.05	PV08	150	200	14.8
10	11.10	PV10	150	200	20.1
12	13.20	PV12	150	200	21.6

### MJ FIELD LOK™ Gland

SIZE Inches	WEIGHT Pounds	DIMENSION Inches				
		A Outside Dia.	B Bolt Hole	C Inside Dia.	D OD Lip	E Gland Height
4	3.3	8.88	7.50	4.90	5.92	1.75
6	5.0	10.87	9.50	7.00	8.02	2.00
8	7.2	13.13	11.75	9.15	10.17	2.25
10	10.2	15.38	14.00	11.20	12.22	2.25
12	11.0	17.63	16.25	13.30	14.32	2.25

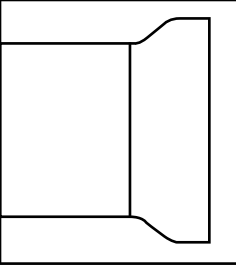

## Warnings and Limitations — Restrained Joints

### Mechanical Joint Set Screw Retainer Glands

U.S. Pipe neither manufactures, nor recommends, the use of mechanical joint set screw-type retainer glands. As an accommodation to our customers and consulting engineers, we do provide set screw-type retainer glands for use where specified in project plans and specifications. Any warranties given for those set screw-type glands sold by U.S. Pipe shall be those warranties given by the manufacturer of the gland involved. **U.S. Pipe makes no warranties, express or implied, concerning those glands, and U.S. Pipe assumes no responsibility for their use.** Where mechanical joint retainer glands are specified, responsibility for the performance of the restraining means shall be that of the engineer, contractor, and/or manufacturer of the glands.

### Special Restrained Joint Installation Considerations

Thrust forces and other special conditions in piping systems can be safely handled with thorough planning and careful attention to detail. When designing the system, the pipeline designer must consider the possible reaction of the pipe under pressure. U.S. Pipe has extensive experience with a wide range of applications involving restrained joints. This expertise is available to any pipeline designer by contacting your U.S. Pipe Sales Representative.

The following sections describe special circumstances that should be considered when designing or installing a restrained joint pipeline.

### Offsets

Horizontal or vertical offsets are commonly encountered in restrained sections of a line. If the restrained joints are not fully extended, the thrust forces at each fitting can extend the line sections, resulting in over deflection of the joints of the offset piping. Such over deflection can transfer bending moments to the piping system and damage the pipe, joint components, or support system. All restrained joints in offset installations should be fully extended to minimize the extension of piping components.

Offsets in restrained sections should be made with as small a degree bend as possible to minimize the thrust loads that will be generated and to maximize the line length and the soil resistance between the fittings of the offset.

### Earthquake or Fault Areas

The flexibility of TR FLEX® Pipe and Fittings, FIELD LOK 350® Gaskets, MJ FIELD LOK® Gaskets, XTRA FLEX® Fittings, and the TR TELE FLEX® Assembly make them suitable for crossing earthquake faults. Telescoping sleeves can be installed in the retracted position, giving the line the capacity to extend in case of severe disturbance of the earth around the pipe. When installed in the retracted position, care must be taken to compact the soil around the assembly to avoid its extension under normal line pressure.

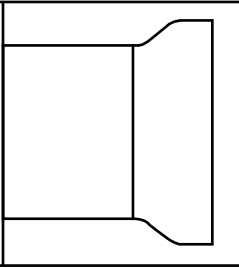

# RESTRAINED JOINTS



2006 EDITION

P 31

## Warnings and Limitations — Restrained Joints (con't)

### Future Excavations

If it is likely that the soil surrounding the pipeline might be removed in future excavations, the design should incorporate adequate thrust restraint with restrained joints, or by combining thrust block and joint restraint methods.

### Electrical Conductivity

Restrained joints may be more electrically conductive than push-on joints because restrained joints have more metal-to-metal contact. This increased conductivity potential makes the line more susceptible to stray electrical currents that may cause corrosion. Stray currents are likely in areas where the pipeline will be exposed to direct currents from electrical transit systems, cathodically protected steel structures such as steel pipe, underground storage tanks, or other sources. As restrained joints do not provide positive electrical conductivity they are not to be used for joint bonding applications such as required for service line thawing and cathodic protection applications. If the pipeline is likely to be exposed to stray currents, or bonded joints are required for service line thawing or cathodic protection applications, contact your U. S. Pipe Sales Representative for recommendations in the handling of these issues.

### Joint Deflection

TR FLEX® Pipe and Fittings restrained joints are designed to deflect slightly without damaging the effectiveness of the restraint or the seal in the joint. Joint deflection should be set after the joint has been completely assembled. See the applicable product brochure for specifications on maximum joint deflection for each pipe size.

**Caution:** *Internal thrust forces may remove any slack in the joints and lengthen the line, causing increased deflection. If such movement is anticipated, the joint should be only deflected a portion of what the design allows during installation. The joints should also be fully extended during installation.*

### Totally Restrained Systems

When there is not enough space to restrain the required length of pipe; where there is no soil (above ground, underwater); also where the surrounding soil offers little or no resistance, all joints can be restrained and extended to enable the pipeline to carry its own thrust forces. A fully restrained piping system is not dependent upon the surrounding soil for thrust resistance.

### High Pressure Applications

TR FLEX Pipe and Fittings have been successfully used for installations requiring higher pressures than the published rated pressures for the product line.

U.S. Pipe Sales Representatives can make design recommendations for higher operating pressures.

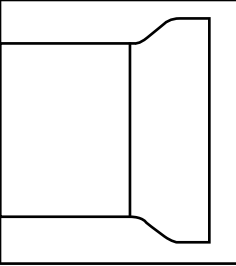

# RESTRAINED JOINTS



2006 EDITION

P 32

## Notes Regarding the Use of Restrained Joint Pipe

1. Large unbalanced thrust forces can be produced at dead ends, bends, tees or other changes in direction of high pressure and/or large diameter piping systems.
2. Concrete thrust blocks are not needed if restrained joint pipe and fittings are utilized per the Ductile Iron Pipe Research Association thrust restraint design for Ductile Iron Pipe.
3. In underground piping systems, an unbalanced thrust force can normally be resisted by providing a designed length of restraint at a change in direction where thrust forces are anticipated. Restrained joint pipe must normally transfer the thrust forces to the soil surrounding the pipeline.
4. "The Thrust Restraint Design for Ductile Iron Pipe" published by the Ductile Iron Pipe Research Association (DIPRA) is one method used to calculate the required length of restraint at a change in direction.
5. Most restrained joints allow for joint take-up after installation. Take-up or slack can vary considerably with the type of joint installation conditions. Thrust forces produced by internal pressures can result in removal of joint take-up thereby increasing the length of the restrained section of the line. In any situation or configuration where increases in the line segment could be detrimental to the pipe line or surrounding structures, the restrained joints should be fully extended during installation.
6. An increase in line segment length can also result in additional joint deflection. If an increase in length or other line movements are anticipated, the deflection of the restrained joints should be limited to only a portion of the joint design deflection during the installation of the pipe.
7. In fully extended, totally restrained piping systems, the thrust forces are carried by the piping system, and the resistance to the thrust is not dependent upon the surrounding soil. In situations where there is insufficient space to provide the designed restrained length, or where there are poor soil conditions, the entire section of line should be restrained or other external means of stability or restraint provided.
8. If restrained joint pipe is used in a casing and is subjected to thrust, the joints should be fully extended to take up the joint slack prior to making end connections. The length of restraint in the casing should not be considered as part of the designed length of the restraint required to provide the soil resistance to the thrust forces.
9. Above ground lines subject to thrust forces should be fully restrained and extended to remove any slack from the joint. The joint can be extended by pulling out on the pipe after the restrained joint assembly is made. The thrust forces can cause an unexpected increase in length of an above ground line if the slack is not first removed from the joint. When restrained joint pipe are used for bridge crossings or other above ground installations, each length of pipe must be supported in a manner to restrict both vertical and horizontal movement.
10. It is the responsibility of the Purchaser or Consulting Engineer to ensure that proper trench preparation, compaction and pipe installation procedures are followed and that adequate restrained lengths or thrust block designs are provided to resist the unbalanced thrust loads generated by the installed piping systems, in accordance with the latest revision of *ANSI/AWWA C600 Installation of Ductile-Iron Water Mains and their Appurtenances*.
11. Restrained joints may be more electrically conductive than push-on joints because restrained joints have more metal-to-metal contact. This increased conductivity potential makes the line more susceptible to stray electrical currents that may cause corrosion. Stray currents are likely in areas where the pipeline will be exposed to direct currents from electrical transit systems, cathodically protected steel structures such as steel pipe, underground storage tanks, or other sources. As restrained joints do not provide positive electrical conductivity they are not to be used for joint bonding applications such as required for service line thawing and cathodic protection applications. If the pipeline is likely to be exposed to stray currents, or bonded joints are required for service line thawing or cathodic protection applications, contact your U. S. Pipe Sales Representative for recommendations in the handling of these issues.
12. When pipe with thick coatings or tape wrap on the outer diameter are cut, the coating or wrap may be too thick for integral restraining devices utilizing gripping teeth. In general, if the peen pattern is not visible on the pipe surface, the coating may be too thick for proper penetration of the teeth. The thick coating must be removed from the end of the pipe before assembly. The coating must be no more than 6 mils thick on the plain end of the pipe.



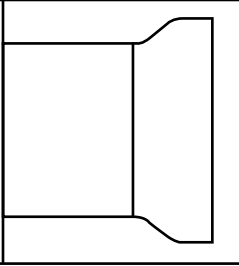

# RESTRAINED JOINTS



2006 EDITION

P 33

## Products for Water, Wastewater and Fire Protection

Ductile Iron Pipe	SIZE RANGE
TYTON JOINT® Pipe	4"-64" Ductile Iron
Mechanical Joint Pipe	4"-12" Ductile Iron
TR FLEX® Pipe	4"-36" Ductile Iron
HP LOK® Pipe	30"-64" Ductile Iron
Flanged Pipe	3"-64" Ductile Iron
Grooved Pipe	4"-36" Ductile Iron
USIFLEX® Boltless Ball Joint Pipe For Subaqueous Installations	4"-48" Ductile Iron
<b>Restrained Joints</b>	
TR FLEX® Restrained Joint	4"-36" Ductile Iron
HP LOK® Restrained Joint	30"-64" Ductile Iron
MJ FIELD LOK® Gaskets	4"-24"
FIELD LOK 350® Gaskets	4"-24"
FIELD LOK® Gasket	30" & 36"
TR FLEX GRIPPER® Rings	4"-36" Ductile Iron
TR TELE FLEX® Assemblies	4"-24" Ductile Iron
<b>Fittings</b>	
TYTON® Fittings	14"-24" Ductile Iron
TRIM TYTON® Fittings	4"-12" Ductile Iron
TR FLEX® Fittings and TR FLEX® Telescoping Sleeves	4"-36" Ductile Iron
HP LOK® Fittings and HP LOK® Telescoping Sleeves	30"-64" Ductile Iron
Mechanical Joint Fittings	30"-48" Ductile Iron
Flanged Fittings	30"-64" Ductile Iron
XTRA FLEX® Couplings	4"-24" Ductile Iron
<b>Miscellaneous Products</b>	
PROTECTO 401™ Lined Ductile Iron Pipe for Domestic Sewage and Industrial Wastes	4"-64" Ductile Iron
GLASS Lined Ductile Iron Pipe for Wastewater Treatment Plants	4"-30" Ductile Iron
RING FLANGE-TYTE® Gaskets	4"-36"
FULL FACE FLANGE-TYTE® Gaskets	4"-64"
MJ Harness-Lok	4"-48" Ductile Iron
Saddle Outlets	Various Ductile Iron
Welded Outlets	Various Ductile Iron
Polyethylene Encasement	4"-64"

*Our products are manufactured in conformance with National Standards so that our customers may be assured of getting the performance and longevity they expect. Use of accessories or other appurtenances that do not comply with recognized standards may jeopardize the performance and longevity of the project.*

*All U.S. Pipe brochures and/or products are  
subject to change without further notice.*

---

P.O. BOX 10406  
BIRMINGHAM, AL 35202  
866.DIP.PIPE (866.347.7473)  
FAX: 205.254.7165  
EMAIL: [INFO@USPIPE.COM](mailto:INFO@USPIPE.COM)  
[WWW.USPIPE.COM](http://WWW.USPIPE.COM)

**MORE  
THAN  
JUST  
PIPE.**

